



Installation manual

ACO kerb PB



- | | | | |
|------------|------------------------------------|------------|----------------------------------|
| ENG | Installation Manual | EST | Paigaldusjuhend |
| GER | Installationsanleitung | LAV | Uzstādīšanas instrukcija |
| FRA | Instructions d´installation | LIT | Montavimo instrukcija |
| ESP | Manual De Instalación | POL | Instrukcja montażu |
| POR | Manual de Instalação | BUL | Инструкции за инсталация |
| ITA | Manuale d´installazione | HUN | Beépítési útmutató |
| NLD | Installatiehandleiding | RUM | Instructiuni de instalare |
| CZE | Instalační manuál | HRV | Upute za ugradnju |
| RUS | Инструкция По Установке | SLV | Navodila za vgradnjo |
| SWE | Installationsanvisning | SRP | Preporuka za ugradnju |
| NOR | Installasjons Manual | | |
| FIN | Asennusohje | | |
| DAN | Installationsvejledning | | |

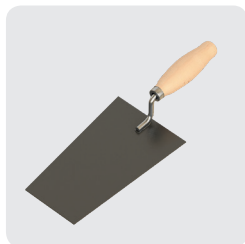
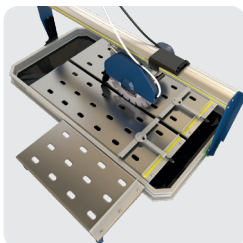
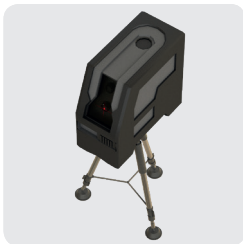

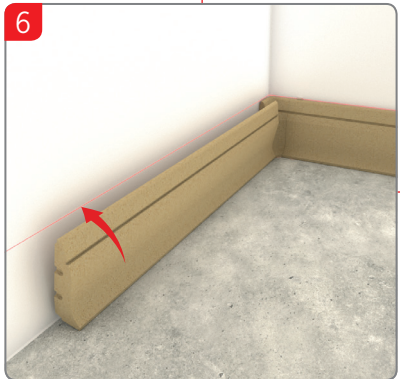
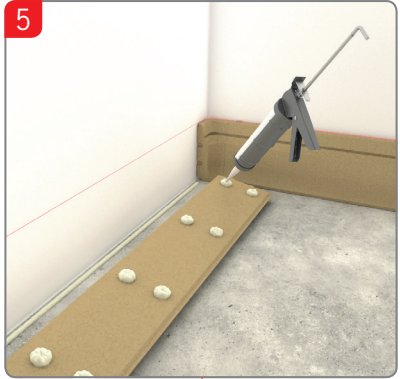
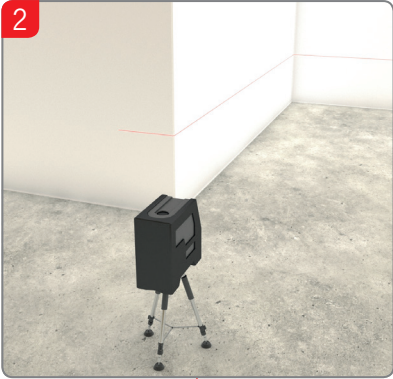
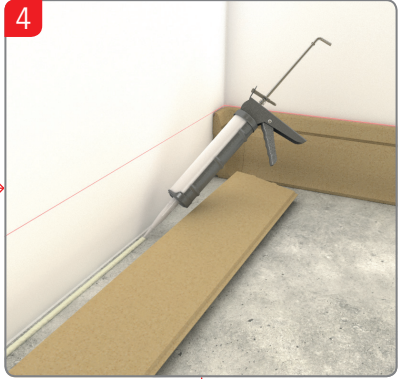
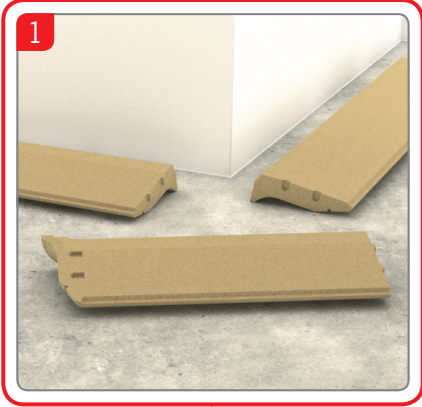

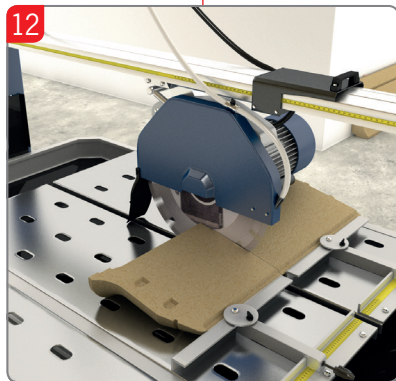
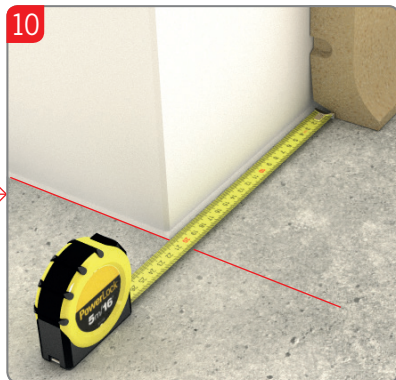
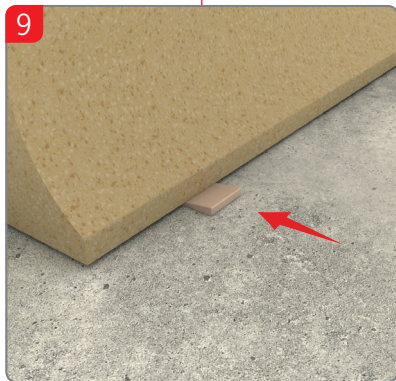
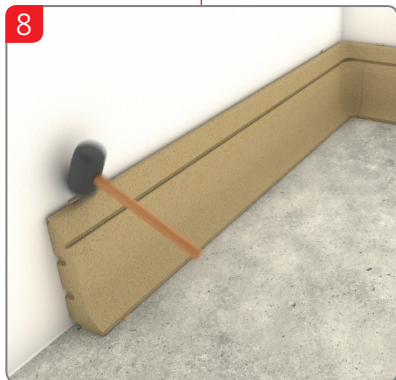
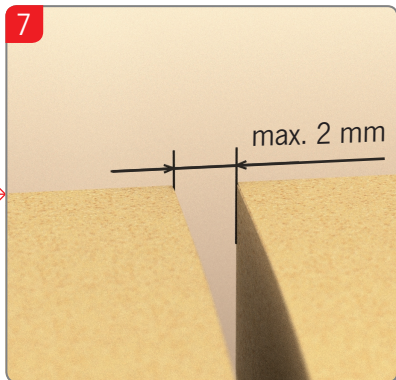

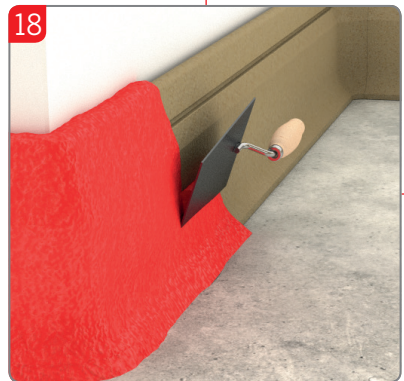
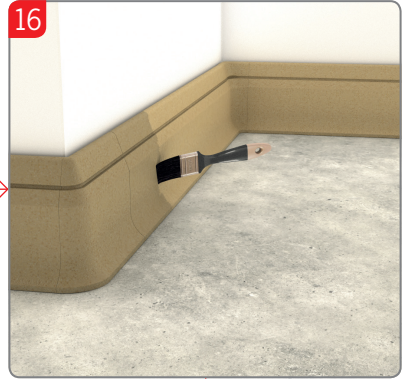
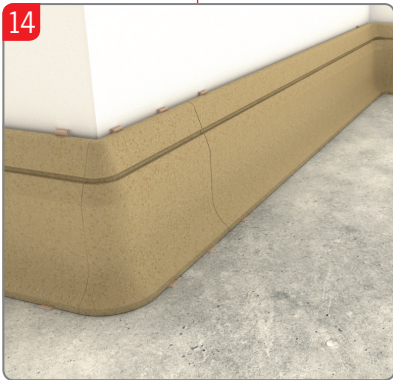

18

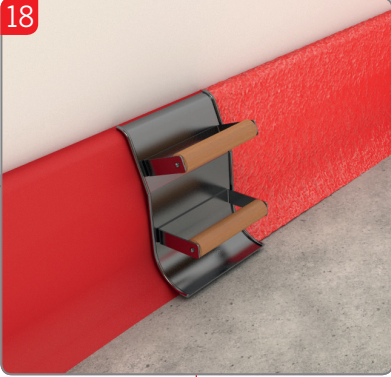

22



20



21

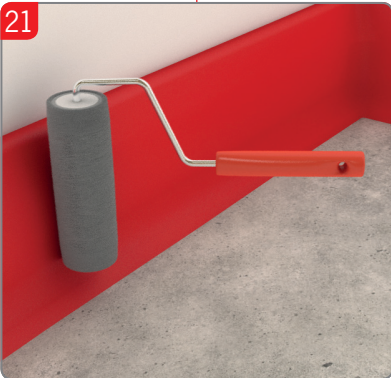

ACO. creating the future of drainage

www.aco-buildingdrainage.com



NM14032

ACO kerb PB Installation/JMa/EN/Q2/18